

SB-0314

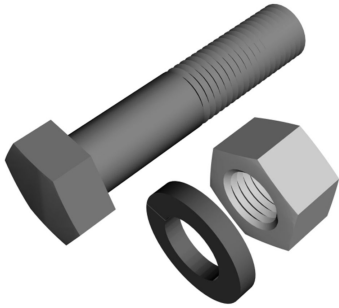

Stainless Steel Bolt, 3/8 in x 1-1/2 in

Product Classification

Product Type Bolt kit

Dimensions

Height 25.4 mm | 1 in

Width 25.4 mm | 1 in

Length 38.1 mm | 1.5 in

Pipe Outer Diameter 10.16 mm | 0.4 in

Material Specifications

Material Type Stainless steel

Packaging and Weights

Included Bolts

Packaging quantity 1

Regulatory Compliance/Certifications

Agency

CHINA-ROHS

ISO 9001:2015

REACH-SVHC

ROHS

Classification

Below maximum concentration value

Designed, manufactured and/or distributed under this quality management system

Compliant as per SVHC revision on www.commscope.com/ProductCompliance

Compliant

