

# WB-TS24

---

Trapeze Kit, 24 in wide, one rung

## Product Classification

**Product Type** Trapeze kit

## General Specifications

**Application** Waveguide bridge kit, 24 in

**Cable Runs, quantity** 6

**Hole, quantity** 6

**Mounting** Waveguide bridge channel

**Rungs, quantity** 1

## Dimensions

**Height** 76.2 mm | 3 in

**Width** 609.6 mm | 24 in

**Length** 76.2 mm | 3 in

**Hole Size** 3/4 in | 7/16 in

# WB-TS24

## Outline Drawing

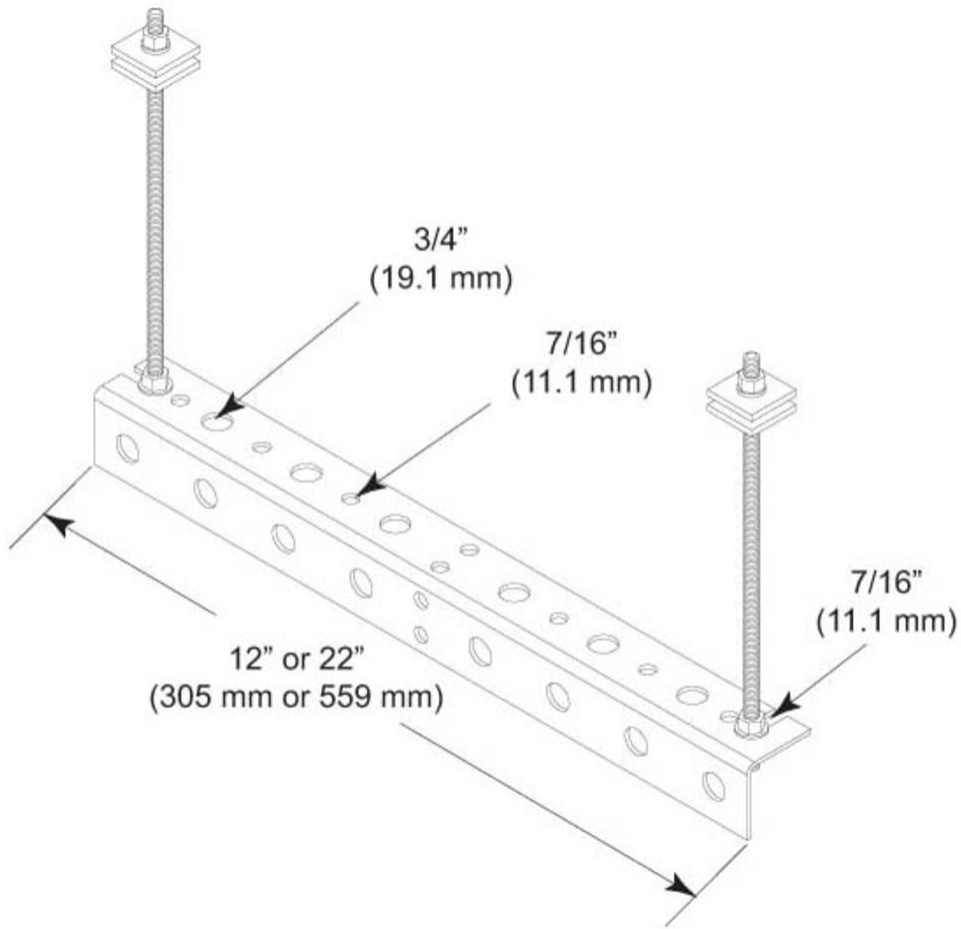

## Material Specifications

**Material Type** Hot dip galvanized steel

## Packaging and Weights

**Included** Angle brackets | Hardware | Threaded rod

**Packaging quantity** 1

**Weight, net** 1.9 kg | 4.189 lb

## Regulatory Compliance/Certifications

**Agency** **Classification**

# WB-TS24

---

CHINA-ROHS	Below maximum concentration value
ISO 9001:2015	Designed, manufactured and/or distributed under this quality management system
REACH-SVHC	Compliant as per SVHC revision on <a href="http://www.commscope.com/ProductCompliance">www.commscope.com/ProductCompliance</a>
ROHS	Compliant

